

PR



9107

HART[®]
Transparent Driver

No. 9107V100-UK
Product version: 9107-001



SIGNALS THE BEST

- DK** ▶ PR electronics A/S tilbyder et bredt program af analoge og digitale signalbehandlingsmoduler til industriel automation. Programmet består af Isolatorer, Displays, Ex-barrierer, Temperaturtransmittere, Universaltransmittere mfl. Vi har modulerne, du kan stole på i selv barske miljøer med elektrisk støj, vibrationer og temperaturudsving, og alle produkter opfylder de strengeste internationale standarder. Vores motto »Signals the Best« er indbegrebet af denne filosofi – og din garanti for kvalitet.
- UK** ▶ PR electronics A/S offers a wide range of analogue and digital signal conditioning modules for industrial automation. The product range includes Isolators, Displays, Ex Interfaces, Temperature Transmitters, and Universal Modules. You can trust our products in the most extreme environments with electrical noise, vibrations and temperature fluctuations, and all products comply with the most exacting international standards. »Signals the Best« is the epitome of our philosophy – and your guarantee for quality.
- FR** ▶ PR electronics A/S offre une large gamme de produits pour le traitement des signaux analogiques et numériques dans tous les domaines industriels. La gamme de produits s'étend des transmetteurs de température aux afficheurs, des isolateurs aux interfaces SI, jusqu'aux modules universels. Vous pouvez compter sur nos produits même dans les conditions d'utilisation sévères, p.ex. bruit électrique, vibrations et fluctuations de température. Tous nos produits sont conformes aux normes internationales les plus strictes. Notre devise »SIGNALS the BEST« c'est notre ligne de conduite - et pour vous l'assurance de la meilleure qualité.
- DE** ▶ PR electronics A/S verfügt über ein breites Produktprogramm an analogen und digitalen Signalverarbeitungsmodulen für die industrielle Automatisierung. Dieses Programm umfasst Displays, Temperaturtransmitter, Ex- und galvanische Signaltrenner, und Universalgeräte. Sie können unsere Geräte auch unter extremen Einsatzbedingungen wie elektrisches Rauschen, Erschütterungen und Temperaturschwingungen vertrauen, und alle Produkte von PR electronics werden in Übereinstimmung mit den strengsten internationalen Normen produziert. »Signals the Best« ist Ihre Garantie für Qualität!

HART® TRANSPARENT DRIVER

9107

CONTENTS

Warning	2
Symbol identification.....	2
Safety instructions.....	2
How to demount system 9000.....	4
EC declaration of conformity	5
Advanced features	6
Application	6
Technical characteristics	6
Applications.....	7
PR 4501 Display / programming front	8
Order codes	9
Electrical specifications.....	9
Visualisation in 4501 of hardware / software error	13
Connections	14
Block diagram	15
Signal error indications without display front.....	16
Configuration / operating the function keys	17
Routing diagram.....	19
Routing diagram, Advanced settings (ADV.SET).....	20
Scrolling help texts in display line 3.....	21
Appendix	22
IECEX Installation Drawing	23
ATEX Installation Drawing	25
FM Installation Drawing.....	27



WARNING

The following operations should only be carried out on a disconnected device and under ESD-safe conditions:
General mounting, connection and disconnection of wires.
Troubleshooting the device.

Repair of the device and replacement of circuit breakers must be done by PR electronics A/S only.



WARNING

Do not open the front plate of the device as this will cause damage to the connector for the display / programming front PR 4501. This device contains no DIP-switches or jumpers.

SYMBOL IDENTIFICATION



Triangle with an exclamation mark: Read the manual before installation and commissioning of the device in order to avoid incidents that could lead to personal injury or mechanical damage.



The CE mark proves the compliance of the device with the essential requirements of the directives.



The double insulation symbol shows that the device is protected by double or reinforced insulation.



Ex devices have been approved according to the ATEX directive for use in connection with installations in explosive areas. See installation drawings in appendix.

SAFETY INSTRUCTIONS

DEFINITIONS

Hazardous voltages have been defined as the ranges: 75...1500 Volt DC, and 50...1000 Volt AC.

Technicians are qualified persons educated or trained to mount, operate, and also troubleshoot technically correct and in accordance with safety regulations.

Operators, being familiar with the contents of this manual, adjust and operate the knobs or potentiometers during normal operation.

RECEIPT AND UNPACKING

Unpack the device without damaging it and check whether the device type corresponds to the one ordered. The packing should always follow the device until this has been permanently mounted.

ENVIRONMENT

Avoid direct sunlight, dust, high temperatures, mechanical vibrations and shock, as well as rain and heavy moisture. If necessary, heating in excess of the stated limits for ambient temperatures should be avoided by way of ventilation.

The device must be installed in pollution degree 2 or better.

The device is designed to be safe at least under an altitude up to 2 000 m.

MOUNTING

Only technicians who are familiar with the technical terms, warnings, and instructions in the manual and who are able to follow these should connect the device.

Should there be any doubt as to the correct handling of the device, please contact your local distributor or, alternatively,

PR electronics A/S
www.prelectronics.com

The use of stranded wires is not permitted for mains wiring except when wires are fitted with cable ends.

Descriptions of input / output and supply connections are shown in the block diagram and on the side label.

The device is provided with field wiring terminals and shall be supplied from a Power Supply having double / reinforced insulation. A power switch shall be easily accessible and close to the device. The power switch shall be marked as the disconnecting unit for the device.

For installation on Power Rail 9400 the power is supplied by Power Control Unit 9410.

Year of manufacture can be taken from the first two digits in the serial number.

CALIBRATION AND ADJUSTMENT

During calibration and adjustment, the measuring and connection of external voltages must be carried out according to the specifications of this manual. The technician must use tools and instruments that are safe to use.

NORMAL OPERATION

Operators are only allowed to adjust and operate devices that are safely fixed in panels, etc., thus avoiding the danger of personal injury and damage. This means there is no electrical shock hazard, and the device is easily accessible.

CLEANING

When disconnected, the device may be cleaned with a cloth moistened with distilled water.

LIABILITY

To the extent that the instructions in this manual are not strictly observed, the customer cannot advance a demand against PR electronics A/S that would otherwise exist according to the concluded sales agreement.

HOW TO DEMOUNT SYSTEM 9000

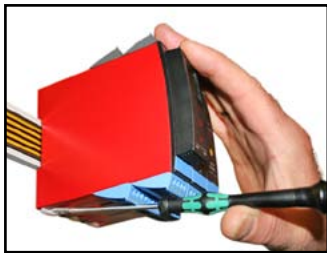

Picture 1:

By lifting the bottom lock, the device is detached from the DIN rail.

EC DECLARATION OF CONFORMITY

As manufacturer

PR electronics A/S
Lerbakken 10
DK-8410 Rønde

hereby declares that the following product:

Type: 9107
Name: HART® transparent driver

is in conformity with the following directives and standards:

The EMC Directive 2004/108/EC and later amendments

EN 61326-1 : 2006

For specification of the acceptable EMC performance level, refer to the electrical specifications for the device.

The Low Voltage Directive 2006/95/EC and later amendments

EN 61010-1 : 2001

The ATEX Directive 94/9/EC and later amendments

EN 61241-0:2006, EN 61241-11:2006, EN 60079-0:2006,
EN 60079-11:2007, EN 60079-15:2005, EN 60079-26:2007
ATEX certificate: DEKRA 11ATEX0247 X

Notified body

DEKRA Certification B.V. (0344)
Utrechtseweg 310, 6812 AR Arnhem
P.O. Box 5185, 6802 ED Arnhem
The Netherlands

Rønde, 1 December 2011



Kim Rasmussen
Manufacturer's signature

HART[®]-TRANSPARENT DRIVER

9107

- *HART[®] transparent Ex driver*
- *Low response time between input and output (< 5 ms)*
- *1 or 2 channels*
- ** SIL 2-certified via Full Assessment according to IEC 61508*
- ** SIL 3 applicable through redundant architecture*

Advanced features

- Monitoring of loop current by way of detachable display front (PR 4501).
- The PR 4501 can be used to define high and low limits for detection of loop current level. If these limits are exceeded, the status relay will activate.
- In the 1-channel version the status relay can be used as a simple limit switch.
- * In a combination of 2 devices the safety system can reach a SIL 3 classification.

Application

- The 9107 can be mounted in the safe area and in zone 2 / div. 2 and transmit signals to zone 0, 1, 2, 20, 21 and 22.
- Ex driver for current signals with 2-way HART[®] communication transmitted to e.g. I/P converters mounted in the hazardous area.
- Dual channel versions can be used for signal splitter applications.
- Monitoring of error events and cable breakage on input via the status relay and/or a collective electronic signal via the power rail.
- * The 9107 has been designed, developed and certified for use in SIL 2 applications according to the requirements of IEC 61508.

Technical characteristics

- 1 green and 2 red front LEDs indicate operation status and malfunction.
- Continuous check of vital stored data for safety reasons.
- 2.6 kVAC galvanic isolation between input, output and supply.
- Can be supplied separately or installed on power rail, PR type 9400.

APPLICATIONS

Output signals:

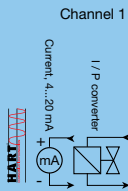

Power rail

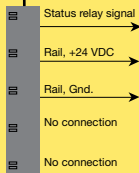

Input signals:

Analogue, 4...20 mA

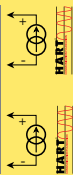

Channel 1

Channel 2

Channel 2

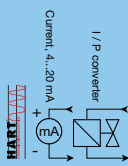

Same power rail as above

Power connection:

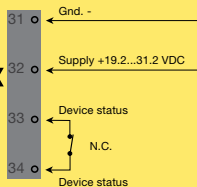

**Zone 0, 1, 2,
20, 21, 22 /
Cl. I/II/III, Div. 1
gr. A-G**

Zone 2 / Cl. 1, Div. 2, gr. A-D or safe area

PR 4501 DISPLAY / PROGRAMMING FRONT



Functionality

The simple and easily understandable menu structure and the explanatory help texts guide you effortlessly and automatically through the configuration steps, thus making the product very easy to use. Functions and configuration options are described in the section "Configuration / operating the function keys".

Application

- Communications interface for modification of operational parameters in 9107.
- When mounted in the process, the display shows process values and module status.

Technical characteristics

- LCD display with 4 lines; Line 1 (H=5.57 mm) shows status for each channel (OK or error). Line 2 (H=3.33 mm) shows loop current in mA for channel 1 or tag no., line 3 (H=3.33 mm) shows loop current in mA for channel 2 or tag no., and line 4 shows communications status.
- In order to protect the configuration against unauthorised changes, access to the menus can be blocked by a password.

Mounting / installation

- Click 4501 onto the front of 9107.

Order codes

9107BA	=	HART® Transparent Driver, 1 channel
9107BB	=	HART® Transparent Driver, 2 channels
4501	=	Display / programming front
9400	=	Power rail

Electrical specifications

Specifications range.....	-20...+60°C
Storage temperature	-20...+85°C

Common specifications:

Supply voltage, DC	19.2...31.2 VDC
Max. consumption, 2 channels.....	< 3 W
Fuse.....	1.25 A SB / 250 VAC
Isolation:	
Outputs to any	300 VAC double/reinforced isolation
Inputs to supply	300 VAC double/reinforced isolation
Status relay to supply	150 VAC double/reinforced or 300 VAC basic isolation
Input 1 to input 2	150 VAC double/reinforced or 300 VAC basic
Communications interface	Programming front 4501
HART® communication, frequency range ...	0.5...2.5 kHz, 2-way
Signal / noise ratio	Min. 60 dB (0.5...10 kHz)
Response time (0...90%, 100...10%)	< 5 ms
Calibration temperature.....	20...28°C
Effect of supply voltage change on output (19.2...31.2 VDC, nom. 24 VDC).....	< ±10 µA

Accuracy, the greater of general and basic values:

General values		
Input type	Absolute accuracy	Temperature coefficient
All	$\leq \pm 0.1\%$ of span	$\leq \pm 0.01\%$ of span / °C

Basic values		
Input type	Basic accuracy	Temperature coefficient
mA	$\leq \pm 16 \mu\text{A}$	$\leq \pm 1.6 \mu\text{A} / ^\circ\text{C}$

EMC immunity influence	$< \pm 0.5\%$ of span
Extended EMC immunity: NAMUR NE 21, A criterion, burst	$< \pm 1\%$ of span

Wire size (max.)	0.13...2.08 mm ² / AWG 26...14 stranded wire
Screw terminal torque	0.5 Nm
Relative humidity	$< 95\%$ RH (non-cond.)
Dimensions, without display front (HxWxD) .	109 x 23.5 x 104 mm
Dimensions, with display front (HxWxD).....	109 x 23.5 x 116 mm
Protection degree.....	IP20
Weight	170 g / 185 g with 4501
DIN rail type.....	DIN 46277

Current input:

Measurement range	3.5...23 mA
Sensor error detection:	
Loop break 4...20 mA	$< 1 \text{ mA}$
Input voltage drop:	
Supplied unit.....	$< 2 \text{ V}$
Non-supplied unit	$< 6 \text{ V}$

Current output:

Signal range (span).....	3.5...23 mA
Load (max.).....	20 mA / 725 Ω / 14.5 VDC
Load stability.....	$\leq 0.01\%$ of span / 100 Ω
Current limit.....	≤ 28 mA

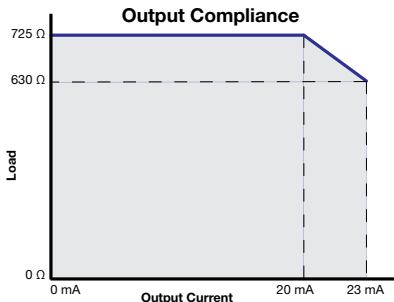
**Relay output:****Status relay:**

Relay function.....	ON / OFF
Programmable low setpoint.....	0...29.9 mA
Programmable high setpoint.....	0...29.9 mA
Hysteresis for setpoints.....	0.1 mA

Status relay in safe area:

Max. voltage.....	125 VAC / 110 VDC
Max. current.....	0.5 AAC / 0.3 ADC
Max. AC power.....	62.5 VA / 32 W

Marine approval:

Det Norske Veritas, Ships & Offshore Pending

GOST R approval:

VNIIFTRI, Cert No..... See www.prelectronics.com

SIL certification:

exida, Cert No..... Pending

Observed authority requirements:	Standard:
EMC 2004/108/EC	EN 61326-1
LVD 2006/95/EC.....	EN 61010-1
ATEX 94/9/EC.....	EN 60079-0, -11, -15 , -26 and EN 61241-0, -11
IECEX.....	IEC 60079-0, -11, -15 and -26 IEC 61241-0 and -11
c FM us	FM 3600, 3611, 3810 CSA E60079-0, -15 CSA 22.2 -25, -142, -213 ANSI/ISA-12.00.01 / 12.12.02
UL, Standard for Safety	UL 61010-1
*SIL.....	* IEC 61508

* = Pending

Visualisation in 4501 of hardware / software error

Readout at hardware error		
Error search	Readout	Cause
Communications test 4501 / 9107	NO.CO	Connection error
EEProm error - check configuration	FL.ER	Configuration error or crc mismatch, recovery configuration is loaded
User error	II !/II !	Loop limit exceeded
User error	II !/II !	Loop error
EEProm error - check configuration	EE.ER / IE.ER	Invalid configuration (CRC or data)
Hardware error	SU.ER	Supply error
Hardware error	RA.ER	RAM error
Hardware error	FL.ER	Flash error
Hardware error	IN.ER	Initialisation error
Hardware error	C1.ER	Hardware error - channel 1
Hardware error	C2.ER	Hardware error - channel 2
Hardware error	DE.ER	General error

! All error indications in the display flash once per second. The help text explains the error. In case of cable fault the backlight also flashes. This can be reset by pressing the  key.

Errors affecting both channels are shown as error on channel 1 - and the line showing channel 2 is blank.

Hardware error can be reset in two ways. Either step through the menus (if the other channel is to stay in operation) or power cycle the device.

CONNECTIONS

Supply:

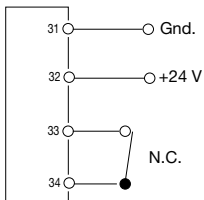

Inputs:

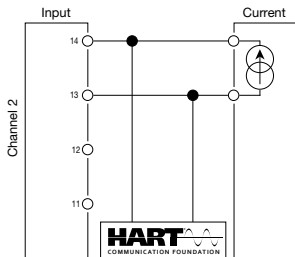
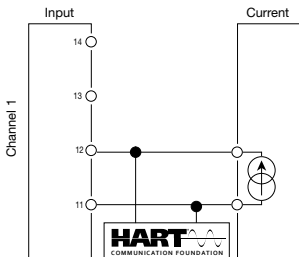

Outputs:

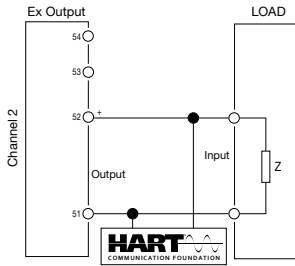
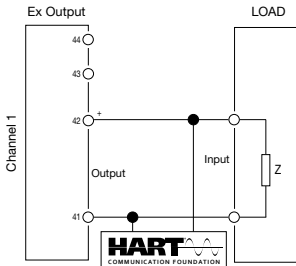

BLOCK DIAGRAM

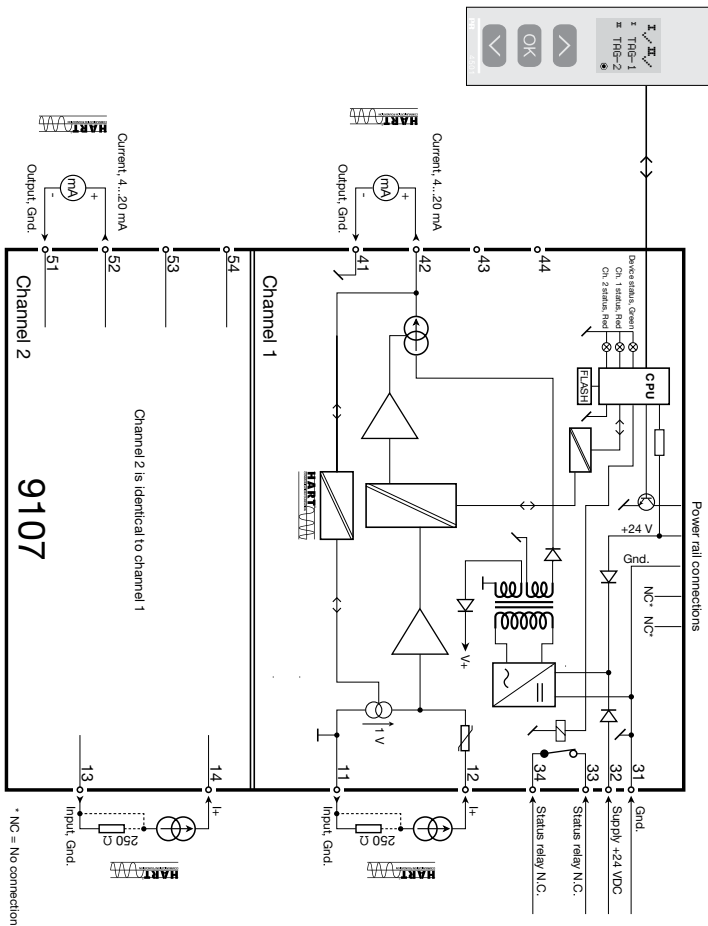

Signal error indications without display front

List of LED and error signal indications					
Condition	Green LED	Ch. 1: Red	Ch. 2: Red	Status relay, N.C.	Power rail signal status
Device OK	Blinking	OFF	OFF	Energized	OFF
No supply	OFF	OFF	OFF	De-energized	ON
Device defective	Blinking	ON	ON	De-energized	ON
Ch. 1 defective (ch. 2 OK)	Blinking	ON	OFF	De-energized	ON
Ch. 2 defective (ch. 1 OK)	Blinking	OFF	ON	De-energized	ON
Ch. 1, signal OK	Blinking	OFF	OFF	Energized	OFF
Ch. 1, signal limit exceeded	Blinking	Blinking	OFF	De-energized	ON (if activated)
Ch. 1, fixed loop break limit exceeded	Blinking	Flashing	OFF	De-energized	ON (if activated)
Ch. 2, signal OK	Blinking	OFF	OFF	Energized	OFF
Ch. 2, signal limit exceeded	Blinking	OFF	Blinking	De-energized	ON (if activated)
Ch. 2, fixed loop break limit exceeded	Blinking	OFF	Flashing	De-energized	ON (if activated)

Blinking : 50% ON and 50% OFF	
Flashing : 8% ON and 92% OFF	

CONFIGURATION / OPERATING THE FUNCTION KEYS

Documentation for routing diagram.

In general

When configuring the 9107, you will be guided through all parameters and you can choose the settings which fit the application. For each menu there is a scrolling help text which is automatically shown in line 3 on the display.

Configuration is carried out by use of the 3 function keys:

- ⬆ will increase the numerical value or choose the next parameter
- ⬇ will decrease the numerical value or choose the previous parameter
- OK will save the chosen value and proceed to the next menu

When configuration is completed, the display will return to the default state 1.0. Pressing and holding OK will return to the previous menu or return to the default state (1.0) without saving the changed values or parameters.

If no key is activated for 1 minute, the display will return to the default state (1.0) without saving the changed values or parameters.

Further explanations

Password protection: Programming access can be blocked by assigning a password. The password is saved in the module in order to ensure a high degree of protection against unauthorised modifications to the configuration. Default password 2008 allows access to all configuration menus.

Loop limits

In the menus LO.LIM and HI.LIM you can choose the current values which will trigger a loop error alarm from the status relay. The NAMUR NE43 limits are selected by setting LO.LIM at 3.6 mA and HI.LIM at 21 mA. This function can be deactivated by selecting limits outside the range 3.5...23 mA. Alternatively, the status relay can be used as a simple limit switch in the 1-channel version.

The loop break limit is fixed ≤ 1 mA. If this limit is exceeded, the status relay will be de-energized.

Signal and sensor error indication via display front 4501

Sensor error (loop break) is shown in line 1 on the display by flashing ! and ! .

The actual mA value is also shown followed by an explanatory text. Channel 1 is shown in line 2 and channel 2 is shown in line 3 on the display.

Line 4 on the display shows the condition of the COM (flashing bullet) indicating correct functioning of 4501.

Advanced functions

The unit gives access to a number of advanced functions which can be reached by answering "Yes" to the point "adv.set".

Display setup: Here you can adjust the brightness contrast and the backlight. Setup of tag numbers with 5 alphanumeric. Selection of functional readout in line 2 and 3 on the display - choose between readout of loop current or tag no. When selecting "ALT" the readout toggles between loop current and tag no.

Password: Here you can choose a password between 0000 and 9999 in order to protect the unit against unauthorised modifications to the configuration. The unit is delivered default without password.

Language: In the menu "LANG" you can choose between 7 different language versions of help texts that will appear in the menu. You can choose between UK, DE, FR, IT, ES, SE and DK.

Power rail: In the menu "RAIL" you can choose if a signal is transmitted to the central surveillance in the PR 9410 power control unit when the signal limits are exceeded..

***Safety Integrity Level (SIL):** See Safety Manual for details.

ROUTING DIAGRAM

If no key is activated for 1 minute, the display will return to the default state 1.0 without saving configuration changes.

⊖ Increase value / choose next parameter

⊕ Decrease value / choose previous parameter

⊙ Save the chosen value and proceed to the next menu

Hold ⊙ Back to previous menu / return to menu 1.0 without saving

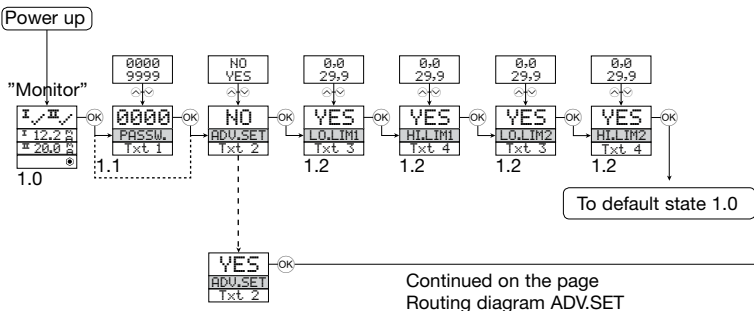

1.0 = "Monitor", Default state.

Line 1 shows status for channel 1 and channel 2

Line 2 shows analogue value or tag no. for channel 1. If the loop limit is exceeded (LO.LIM and HI.LIM) the analogue value is shown for 5 sec. followed by txt 18. In case of loop break, 0.0 is shown for 5 sec. followed by txt 19.

Line 3 shows the same as line 2, only for channel 2.

Line 4 shows status for relay and communication.

1.1 = Only if password-protected.

1.2 = Loop current limits (identical for both channels) can be deactivated by selecting values outside the range 3.5...23 mA.

Line 1 symbols:

⊖ = OK. Flashing ⊖! = error.

ROUTING DIAGRAM, ADVANCED SETTINGS (ADV.SET)

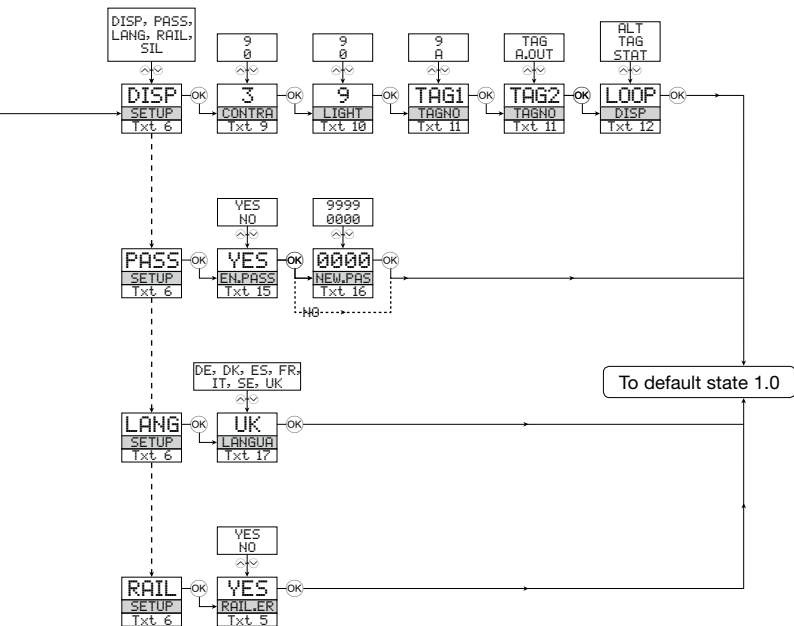

SCROLLING HELP TEXTS IN DISPLAY LINE 3

- [01] Set correct password [PASS]
- [02] Enter advanced setup? [ADV.SET]
- [03] Set low limit for loop error detection [LO.LIM1] [LO.LIM2]
- [04] Set high limit for loop error detection [HI.LIM1] [HI.LIM2]
- [05] Enable DIN-rail status signal output? [RAIL.ER]
- [06] Enter Language setup [SETUP]
 - Enter Password setup [SETUP]
 - Enter Display setup [SETUP]
 - Enter DIN-rail setup [SETUP]
- [09] Adjust LCD contrast [CONTRA]
- [10] Adjust LCD backlight [LIGHT]
- [11] Write a 5-character channel tag ["TAGON] ["TAGON]
- [12] Show loop values in display
 - Show TAG in display
 - Alternate TAG and loop value in display
- [15] Enable password protection? [EN.PASS]
- [16] Set new password [NEW.PAS]
- [17] Select language [LANGUA]
- [18] Loop signal limit exceeded
- [19] Loop wire breakage
- [20] No communication - check connections
- [21] EEprom error - check configurations
- [22] Hardware error

APPENDIX

IECEX Installation drawing
ATEX Installation drawing
FM Installation drawing

IECEX Installation drawing



For safe installation of 9107B the following must be observed. The module shall only be installed by qualified personnel who are familiar with the national and international laws, directives and standards that apply to this area.
Year of manufacture can be taken from the first two digits in the serial number.



For Installation in Zone 2 the following must be observed.
The 4501 programming module is to be used solely with PRelectronics modules. It is important that the module is undamaged and has not been altered or modified in any way. Only 4501 modules free of dust and moisture shall be installed.

9107BA: 1 channel HART[®] transparent driver

9107BB: 2 channel HART[®] transparent driver

IECEX Certificate:IECEX DEK 11.0088X

Marking [Ex ia Ga] IIC/IIB/IIA
Ex nA nC IIC T4 Gc
[Ex ia Da] IIIC
[Ex ia Ma] I

Standards IEC60079-15 :2005, IEC60079-11:2011, IEC60079-0: 2011
IEC60079-26: 2006

Supply terminal (31,32)

Voltage: 19.2 – 31.2 VDC

Status Relay, terminal (33,34)

Voltage max:	125 VAC / 110 VDC	Zone 2 Installation 32 VAC / 32 VDC
Power max:	62.5 VA / 32 W	16 VA / 32 W
Current max:	0.5 A AC / 0.3 ADC	0.5 A AC / 1 ADC

Installation notes:

Install in pollution degree 2, overvoltage category II as defined in IEC 60664-1

Do not separate connectors when energized and an explosive gas mixture is present.
Do not mount or remove modules from the Power Rail when an explosive gas mixture is present.
Disconnect power before servicing.
The wiring of unused terminals is not allowed.

In type of protection [Ex ia Da] the parameters for intrinsic safety for gas group IIB are applicable.

For installation in Zone 2, the module shall be installed in an enclosure in type of protection Ex n or Ex e, providing a degree of protection of at least IP54. Cable entry devices and blanking elements shall fulfill the same requirements.

For installation on Power Rail in Zone 2, only Power Rail type 9400 supplied by Power Control Unit type 9410 (Type Examination Certificate KEMA 07ATEX0152 X) is allowed.

Hazardous area

Zone 0,1,2, 20, 21, 22

Non Hazardous area

or Zone 2

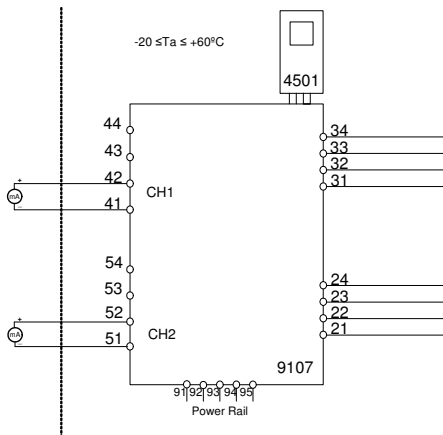
 (terminal 11,12,13,14)
 (terminal 31,32,33,34)
 (terminal 91,92,93,94,95)
 Um: 253 V, max. 400 Hz

CH1 (terminal 41,42)
CH2 (terminal 51,52)
 U_o : 28 V

 I_o : 93 mA

 P_o : 0.65 W

	IIC	IIB	IIA	I
C_o	0.080 μ F	0.650 μ F	2.15 μ F	3.76 μ F
L_o	4 mH	16 mH	32 mH	35 mH

ATEX Installation drawing



For safe installation of 9107B the following must be observed. The module shall only be installed by qualified personnel who are familiar with the national and international laws, directives and standards that apply to this area.

Year of manufacture can be taken from the first two digits in the serial number.



For Installation in Zone 2 the following must be observed.

The 4501 programming module is to be used solely with PRelectronics modules. It is important that the module is undamaged and has not been altered or modified in any way. Only 4501 modules free of dust and moisture shall be installed.

9107BA: 1 channel HART[®] transparent driver

9107BB: 2 channel HART[®] transparent driver

ATEX Certificate: DEKRA 11 ATEX0247X

Marking

II (1) G [Ex ia Ga] IIC/IIB/IIA
II 3G Ex nA nC IIC T4 Gc
II (1) D [Ex ia Da] IIIC
I M (1) [Ex ia Ma] I

Standards

EN 60079-0 : 2009, EN 60079-11 : 2007, EN 60079-15 : 2005
EN 60079-26 : 2007, EN 61241-11 : 2006

Supply terminal (31,32)

Voltage : 19.2 – 31.2 VDC

Status Relay. terminal (33,34)

Zone 2 Installation

Voltage max: 125 VAC / 110 VDC

32 VAC / 32 VDC

Power max: 62.5 VA / 32 W

16 VA / 32 W

Current max: 0.5 A AC / 0.3 ADC

0.5 A AC / 1 ADC

Installation notes:

Install in pollution degree 2, overvoltage category II as defined in EN 60664-1

Do not separate connectors when energized and an explosive gas mixture is present.

Do not mount or remove modules from the Power Rail when an explosive gas mixture is present.

Disconnect power before servicing.

The wiring of unused terminals is not allowed.

In type of protection [Ex ia Da] the parameters for intrinsic safety for gas group IIB are applicable.

For installation in Zone 2, the module shall be installed in an enclosure in type of protection Ex n or Ex e, providing a degree of protection of at least IP54. Cable entry devices and blanking elements shall fulfill the same requirements.

For installation on Power Rail in Zone 2, only Power Rail type 9400 supplied by Power Control Unit type 9410 (Type Examination Certificate KEMA 07ATEX0152 X) is allowed.

LERBAKKEN 10, 8410 RØNDE DENMARK

 Hazardous area
 Zone 0,1,2, 20, 21, 22

 Non Hazardous area
 or Zone 2

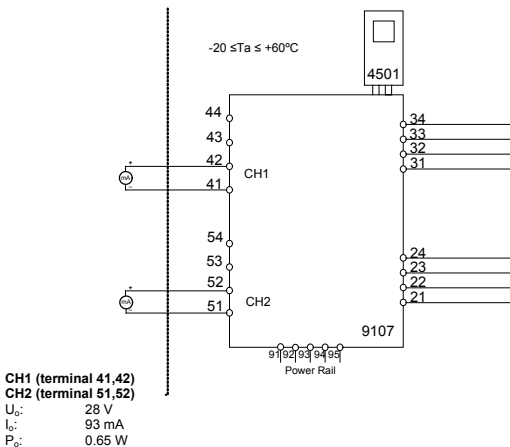
 (terminal 11,12,13,14)
 (terminal 31,32,33,34)
 (terminal 91,92,93,94,95)
 Um: 253 V, max. 400 Hz

	IIC	IIB	IIA	I
C_o	0.080 μ F	0.650 μ F	2.15 μ F	3.76 μ F
L_o	4 mH	16 mH	32 mH	35 mH

FM Installation drawing



For safe installation of 9107B the following must be observed. The module shall only be installed by qualified personnel who are familiar with the national and international laws, directives and standards that apply to this area.

Year of manufacture can be taken from the first two digits in the serial number.



For Installation in Zone 2 the following must be observed.

The 4501 programming module is to be used solely with PRelectronics modules. It is important that the module is undamaged and has not been altered or modified in any way. Only 4501 modules free of dust and moisture shall be installed.

9107BA:	1 channel HART® transparent driver
9107BB:	2 channel HART® transparent driver

Supply terminal (31,32)

Voltage: 19.2 – 31.2 VDC

Status Relay. terminal (33,34)

Voltage max: 125 VAC / 110 VDC
Power max: 62.5 VA / 32 W
Current max: 0.5 A AC / 0.3 ADC

Zone 2 installation:
Voltage max: 32 VAC / 32 VDC
Power max: 16 VA / 32 W
Current max: 0.5 A AC / 1 ADC

Installation notes:

In Class I, Division 2 installations, the subject equipment shall be mounted within a tool-secured enclosure which is capable of accepting one or more of the Class I, Division 2 wiring methods specified in the National Electrical Code (ANSI/NFPA 70) or Canadian Electrical Code (C22.1).

The equipment shall be installed in an enclosure with a minimum ingress protection rating of IP54 unless the apparatus is intended to be afforded an equivalent degree of protection by location. The module is galvanically isolated and does not require grounding.

Install in pollution degree 2, overvoltage category II.

Use 60 / 75 °C copper conductors with wire size AWG: (26-14)

In type of protection "intrinsic safety iD" the parameters for intrinsic safety for gas group IIB are applicable.

Warning: Substitution of components may impair intrinsic safety.

Warning: To prevent ignition of the explosive atmospheres, disconnect power before servicing and do not separate connectors when energized and an explosive gas mixture is present.

Warning: Do not install or remove modules from the Power Rail when an explosive gas mixture is present.

LERBAKKEN 10, 8410 RØNDE DENMARK

Hazardous Classified Location

 Class I / II / III, Division 1, Group A,B,C,D,E,F,G
 Class I Zone 0 / 1 / 2 Group IIC, IIB, IIA or
 Zone 20 / 21

**Unclassified Location or
Hazardous Classified Location**

 Class I, Division 2 Group A,B,C,D T4
 Class I, Zone 2, Group IIC, IIB, IIA T4

 Simple Apparatus or
 Intrinsic safe apparatus
 with entity parameters:

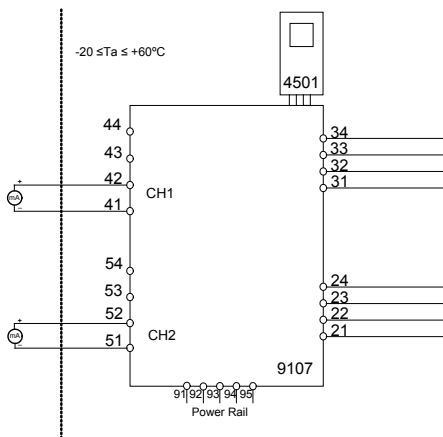
 $V_{max}(U_i) \geq V_t(U_o)$
 $I_{max}(I_i) \geq I_t(I_o)$
 $P_i \geq P_t(P_o)$
 $C_a \geq C_{cable} + C_i$
 $L_a \geq L_{cable} + L_i$

CH1 (terminal 41,42)
CH2 (terminal 51,52)
 $U_o, Voc: 28\text{ V}$
 $I_o, Isc: 93\text{ mA}$
 $P_o: 0.65\text{ W}$

	IIC or A,B	IIB or C,E,F	IIA or D,G
C_o	0.08 μ F	0.650 μ F	2.15 μ F
L_o	4 mH	16 mH	32 mH

 (terminal 11,12,13,14)
 (terminal 31,32,33,34)
 (terminal 91,92,93,94,95)
 $U_m: 253\text{ V, max. }400\text{ Hz}$

 Revision date:
 2011-11-02

 Version Revision
 V2 R0

 Prepared by:
 PB

 Page:
 2/2



Displays Programmable displays with a wide selection of inputs and outputs for display of temperature, volume and weight, etc. Feature linearisation, scaling, and difference measurement functions for programming via PReset software.



Ex interfaces Interfaces for analogue and digital signals as well as HART® signals between sensors / I/P converters / frequency signals and control systems in Ex zone 0, 1 & 2 and for some modules in zone 20, 21 & 22.



Isolation Galvanic isolators for analogue and digital signals as well as HART® signals. A wide product range with both loop-powered and universal isolators featuring linearisation, inversion, and scaling of output signals.























Temperature A wide selection of transmitters for DIN form B mounting and DIN rail modules with analogue and digital bus communication ranging from application-specific to universal transmitters.



Universal PC or front programmable modules with universal options for input, output and supply. This range offers a number of advanced features such as process calibration, linearisation and auto-diagnosis.



- 
 www.preelectronics.fr
 sales@preelectronics.fr
- 
 www.preelectronics.de
 sales@preelectronics.de
- 
 www.preelectronics.es
 sales@preelectronics.es
- 
 www.preelectronics.it
 sales@preelectronics.it
- 
 www.preelectronics.se
 sales@preelectronics.se
- 
 www.preelectronics.co.uk
 sales@preelectronics.co.uk
- 
 www.preelectronics.com
 sales@preelectronics.com

Head office

Denmark
 PR electronics A/S
 Lerbakken 10
 DK-8410 Rønde

www.preelectronics.com
sales@preelectronics.dk
 tel. +45 86 37 26 77
 fax +45 86 37 30 85



QUALITY SYSTEM AND ENVIRONMENTAL MANAGEMENT SYSTEM
 DS/EN ISO 9001
 DS/EN ISO 14001

